



# 4-Channel EMI Filter Array with ESD Protection

## CM1425

### Features

- Four channels of EMI filtering with ESD protection
- Pin compatible with CMD's CSPRC032A
- Greater than 30dB attenuation over the 800MHz to 3GHz frequency range
- $\pm 15$ kV ESD protection (IEC 61000-4-2, contact discharge)
- $\pm 30$ kV ESD protection (HBM)
- 9-bump, 2.470mm x 0.970mm footprint Chip Scale Package (CSP)
- Available with *OptiGuard*<sup>™</sup> coating for improved reliability
- Lead-free versions available

### Applications

- Filtering for antenna and keypad data lines
- I/O port protection for mobile handsets, notebook computers, PDAs etc.
- EMI filtering for data ports in cell phones, PDAs or notebook computers.
- EMI filtering for LCD and chip-to-chip data lines in mobile electronic devices that use flexible PCB interconnections

### Product Description

The CM1425 is an EMI filter array with ESD protection, which integrates 4 pi filters (C-R-C). The CM1425 has component values of 20pF-100 $\Omega$ -20pF. The parts include ESD protection diodes on every pin, which provide a very high level of protection for sensitive electronic components that may be subjected to electrostatic discharge (ESD). The ESD diodes connected to the filter ports safely dissipate ESD strikes of  $\pm 15$ kV, well beyond the maximum requirement of the IEC 61000-4-2 international standard. Using the MIL-STD-883 (Method 3015) specification for Human Body Model (HBM) ESD, the pins are protected for contact discharges at greater than  $\pm 30$ kV.

This device is particularly well-suited for portable electronics (e.g. mobile handsets, PDAs, notebook computers) because of its small package and easy-to-use pin assignments. In particular, the CM1425 is ideal for EMI filtering and protecting data lines from ESD in wireless handsets.

All CM1425 devices are optionally available with *OptiGuard*<sup>™</sup> coating which results in improved reliability at assembly. These devices are also available with standard and lead-free finishing. The CM1425 is housed in a space-saving, low-profile, chip-scale package and is fabricated with the Centurion<sup>™</sup> processes.

### Block Diagram

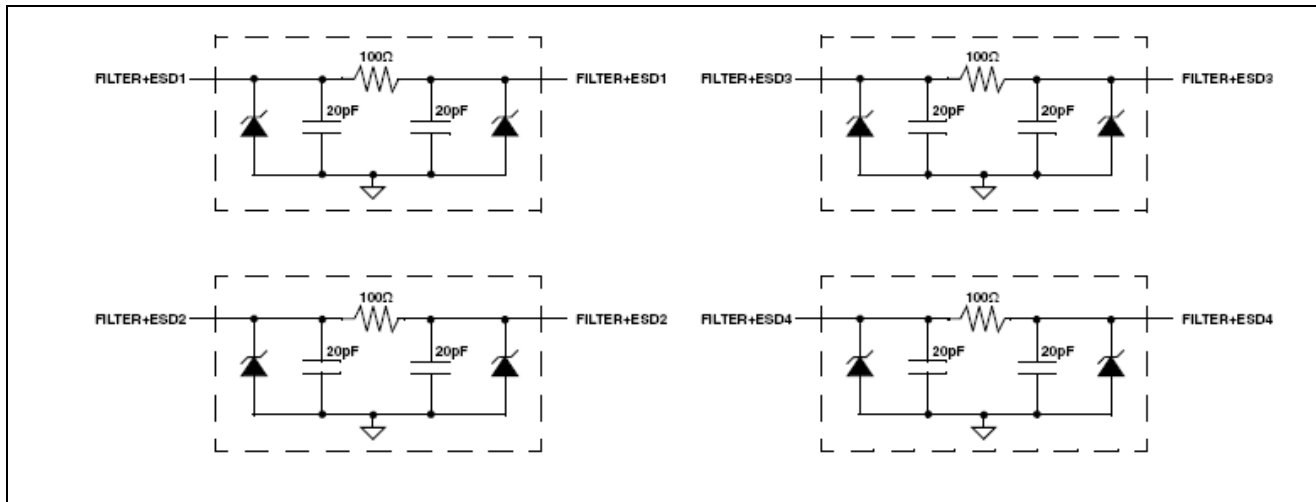

### PACKAGE / PINOUT DIAGRAMS

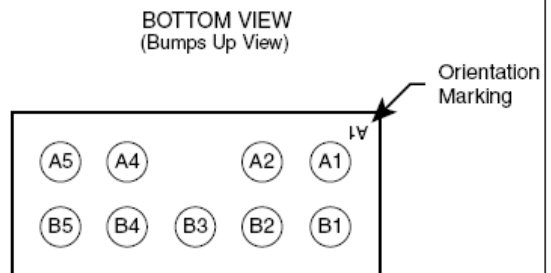
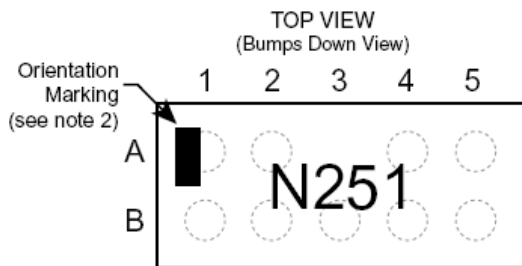

CM1425-01  
CSP Package (No coating)

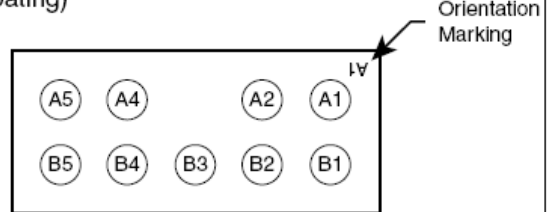
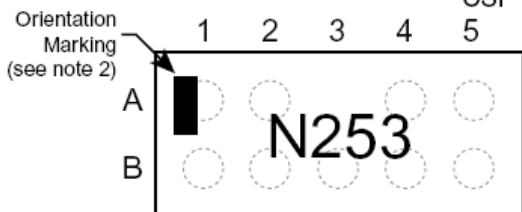

CM1425-03  
CSP Package (OptiGuard™ coating)

Notes:

- 1) These drawings are not to scale.
- 2) Lead-free devices are specified by using a "+" character for the top side orientation mark.

CM1425

### PIN DESCRIPTIONS

PIN(s)	NAME	DESCRIPTION	PIN(s)	NAME	DESCRIPTION
A1	FILTER+ESD1	Filter Channel 1	B1	FILTER+ESD1	Filter Channel 1
A2	FILTER+ESD2	Filter Channel 2	B2	FILTER+ESD2	Filter Channel 2
A4	FILTER+ESD3	Filter Channel 3	B4	FILTER+ESD3	Filter Channel 3
A5	FILTER+ESD4	Filter Channel 4	B5	FILTER+ESD4	Filter Channel 4
B3	GND	Device Ground			

### Ordering Information

#### PART NUMBERING INFORMATION

Bumps	PKG	Standard Finish				Lead-free Finish <sup>2</sup>			
		No Coating		OptiGuard™ Coated		-No Coating		OptiGuard™ Coated	
		Ordering Part Number <sup>1</sup>	Part Marking	Ordering Part Number <sup>1</sup>	Part Marking	Ordering Part Number <sup>1</sup>	Part Marking	Ordering Part Number <sup>1</sup>	Part Marking
9	CSP	CM1425-01CS	N251	CM1425-03CS	N253	CM1425-01CP	N251	CM1425-03CP	N253

Note 1: Parts are shipped in Tape & Reel form unless otherwise specified.

Note 2: Lead-free devices are specified by using a "+" character for the top side orientation mark.

### Specifications

#### ABSOLUTE MAXIMUM RATINGS

PARAMETER	RATING	UNITS
Storage Temperature Range	-65 to +150	°C
Power Rating per Resistor	100	mW
Package Power Rating	300	mW

#### STANDARD OPERATING CONDITIONS

PARAMETER	RATING	UNITS
Operating Temperature Range	-40 to +85	°C

**ELECTRICAL OPERATING CHARACTERISTICS<sup>1</sup>**

SYMBOL	PARAMETER	CONDITIONS	MIN	TYP	MAX	UNITS
R	Resistance		80	100	120	Ω
C	Capacitance	At 2.5V DC, 1MHz, 30mV AC	16	20	24	pF
V <sub>DIODE</sub>	Diode Standoff Voltage	I <sub>DIODE</sub> = 10μA		6.0		V
I <sub>LEAK</sub>	Diode Leakage Current (reverse bias)	V <sub>DIODE</sub> = + 3.3V		100	300	nA
V <sub>SIG</sub>	Signal Voltage Positive Clamp Negative Clamp	I <sub>LOAD</sub> = 10mA I <sub>LOAD</sub> = -10mA	5.6 -1.5	6.8 -0.8	9.0 -0.4	V V
V <sub>ESD</sub>	In-system ESD Withstand Voltage a) Human Body Model, MIL-STD-883, Method 3015 b) Contact Discharge per IEC 61000-4-2 Level 4	Note 2	±30 ±15			kV kV
R <sub>DYN</sub>	Dynamic Resistance Positive Negative			1.5 0.9		Ω Ω
f <sub>c</sub>	Cut-off Frequency Z <sub>SOURCE</sub> =50Ω, Z <sub>LOAD</sub> =50Ω	R = 100Ω, C = 20pF		86		MHz

Note 1: T<sub>A</sub>=25°C unless otherwise specified.

Note 2: ESD applied to input and output pins with respect to GND, one at a time.

Performance Information

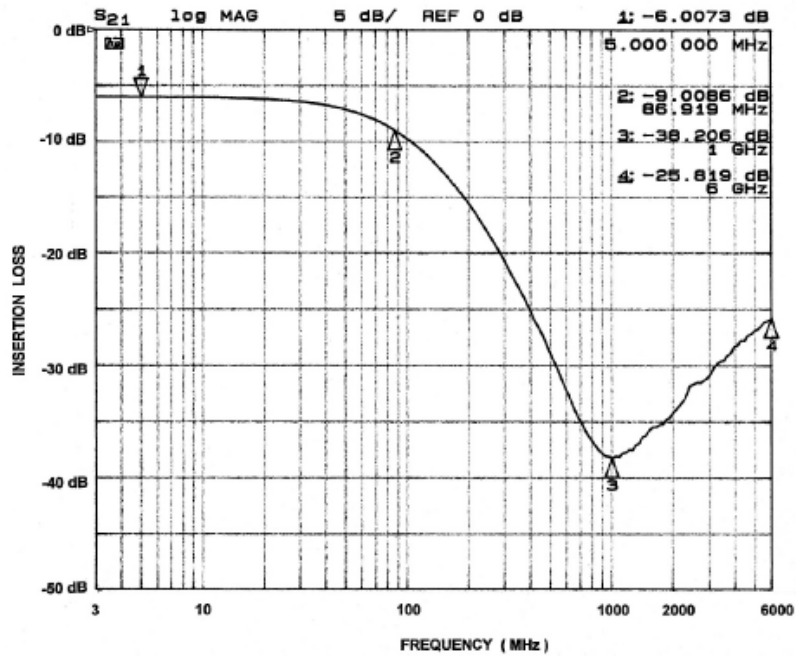

Figure 1. CM1425 Filter Typical Measured Frequency Response

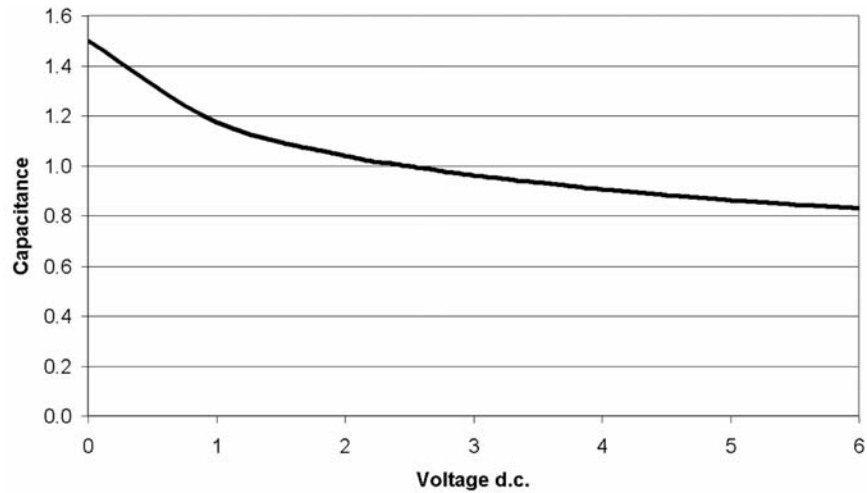

Figure 2. Filter Capacitance vs. Input Voltage over Temperature (normalized to capacitance at 2.5VDC and 25°C)

## Application Information

PARAMETER	VALUE
Pad Size on PCB	0.240mm
Pad Shape	Round
Pad Definition	Non-Solder Mask defined pads
Solder Mask Opening	0.290mm Round
Solder Stencil Thickness	0.125mm - 0.150mm
Solder Stencil Aperture Opening (laser cut, 5% tapered walls)	0.300mm Round
Solder Flux Ratio	50/50 by volume
Solder Paste Type	No Clean
Pad Protective Finish	OSP (Entek Cu Plus 106A)
Tolerance — Edge To Corner Ball	±50µm
Solder Ball Side Coplanarity	±20µm
Maximum Dwell Time Above Liquidous	60 seconds
Maximum Soldering Temperature for Lead-free Devices using a Lead-free Solder Paste	260°C

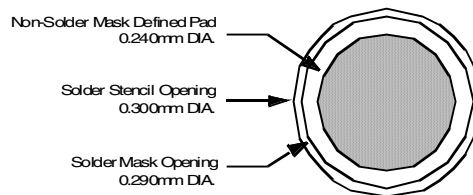

Figure 5. Recommended Non-Solder Mask Defined Pad Illustration

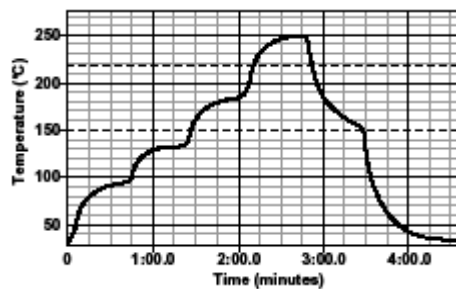

Figure 6. Lead-free (SnAgCu) Solder Ball Reflow Profile

# CM1425

## Mechanical Details

CM1425 devices are packaged in a custom 9-bump custom Chip Scale Packages (CSP) and available with optional *OptiGuard™* coating. Dimensions are presented below.

PACKAGE DIMENSIONS						
Package	Custom CSP					
Bumps	9					
Dim	Millimeters			Inches		
	Min	Nom	Max	Min	Nom	Max
A1	0.925	0.970	1.015	0.0364	0.0382	0.0400
A2	2.425	2.470	2.515	0.0955	0.0972	0.0990
B1	0.495	0.500	0.505	0.0195	0.0197	0.0199
B2	0.495	0.500	0.505	0.0195	0.0197	0.0199
C1	0.185	0.235	0.285	0.0073	0.0093	0.0112
C2	0.185	0.235	0.285	0.0073	0.0093	0.0112
D1 <sup>1</sup>	0.562	0.606	0.650	0.0221	0.0239	0.0256
D2 <sup>1</sup>	0.356	0.381	0.406	0.0140	0.0150	0.0160
D3 <sup>2</sup>	0.575	0.644	0.714	0.0226	0.0254	0.0281
D4 <sup>2</sup>	0.368	0.419	0.470	0.0145	0.0165	0.0185
# per tape and reel	3500 pieces					
Controlling dimension: millimeters						

Note 1: Applies to uncoated devices only.  
 Note 2: Applies to *OptiGuard™* (coated) devices only.

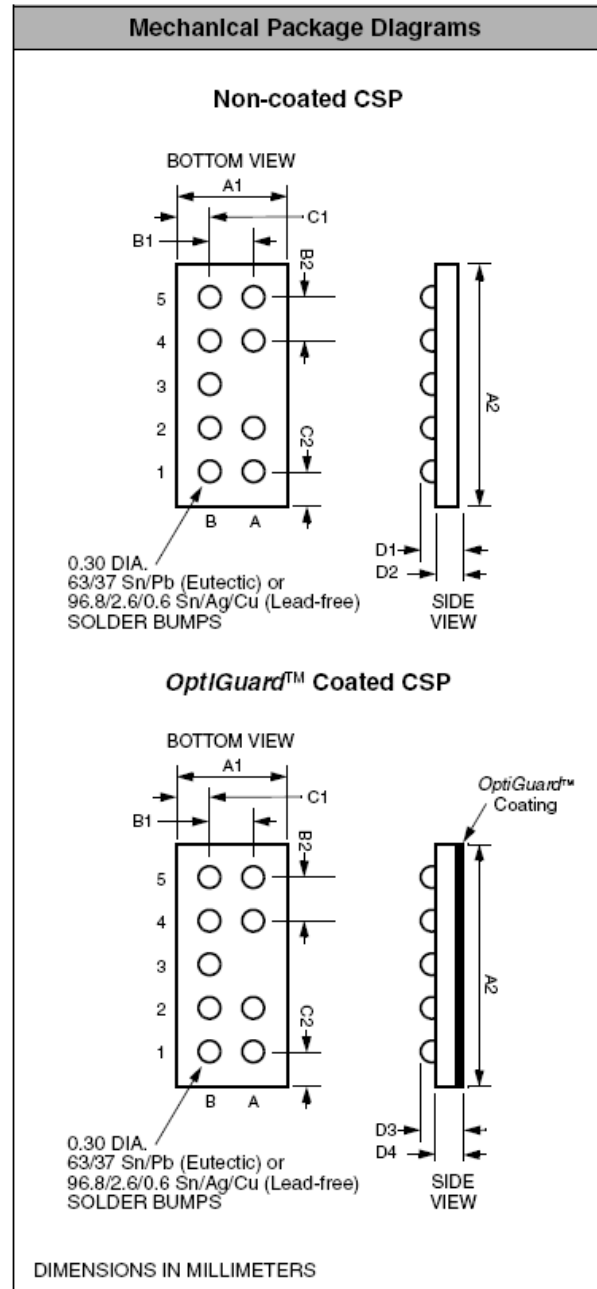

**Package Dimensions  
 CM1425 9-bump Chip Scale Package**

## Mechanical Details (cont'd)

### CSP Tape and Reel Specifications

PART NUMBER	PKG. SIZE (mm)	POCKET SIZE (mm) $B_0 \times A_0 \times K_0$	TAPE WIDTH W	REEL DIA.	QTY PER REEL	$P_0$	$P_1$
CM1425-01	2.470 X 0.970 X 0.606	2.62 X 1.12 X 0.762	8mm	178mm (7")	3500	4mm	4mm
CM1425-03	2.470 X 0.970 X 0.644	2.62 X 1.12 X 0.762	8mm	178mm (7")	3500	4mm	4mm

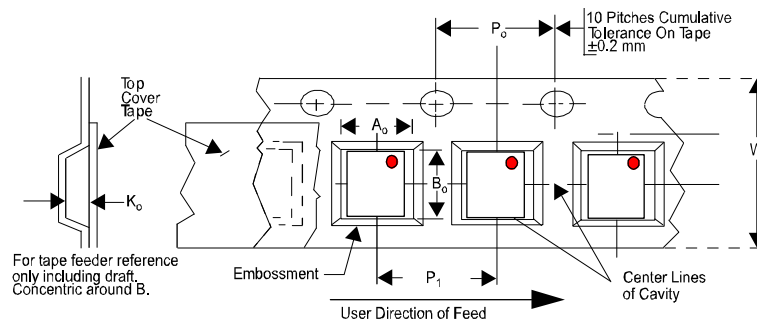

**Figure 6. Tape and Reel Mechanical Data**



ON Semiconductor and  are registered trademarks of Semiconductor Components Industries, LLC (SCILLC). SCILLC reserves the right to make changes without further notice to any products herein. SCILLC makes no warranty, representation or guarantee regarding the suitability of its products for any particular purpose, nor does SCILLC assume any liability arising out of the application or use of any product or circuit, and specifically disclaims any and all liability, including without limitation special, consequential or incidental damages. "Typical" parameters which may be provided in SCILLC data sheets and/or specifications can and do vary in different applications and actual performance may vary over time. All operating parameters, including "Typicals" must be validated for each customer application by customer's technical experts. SCILLC does not convey any license under its patent rights nor the rights of others. SCILLC products are not designed, intended, or authorized for use as components in systems intended for surgical implant into the body, or other applications intended to support or sustain life, or for any other application in which the failure of the SCILLC product could create a situation where personal injury or death may occur. Should Buyer purchase or use SCILLC products for any such unintended or unauthorized application, Buyer shall indemnify and hold SCILLC and its officers, employees, subsidiaries, affiliates, and distributors harmless against all claims, costs, damages, and expenses, and reasonable attorney fees arising out of, directly or indirectly, any claim of personal injury or death associated with such unintended or unauthorized use, even if such claim alleges that SCILLC was negligent regarding the design or manufacture of the part. SCILLC is an Equal Opportunity/Affirmative Action Employer. This literature is subject to all applicable copyright laws and is not for resale in any manner.

## PUBLICATION ORDERING INFORMATION

### LITERATURE FULFILLMENT:

Literature Distribution Center for ON Semiconductor  
P.O. Box 5163, Denver, Colorado 80217 USA  
**Phone:** 303-675-2175 or 800-344-3860 Toll Free USA/Canada  
**Fax:** 303-675-2176 or 800-344-3867 Toll Free USA/Canada  
**Email:** [orderlit@onsemi.com](mailto:orderlit@onsemi.com)

**N. American Technical Support:** 800-282-9855  
Toll Free USA/Canada  
**Europe, Middle East and Africa Technical Support:**  
Phone: 421 33 790 2910  
**Japan Customer Focus Center**  
Phone: 81-3-5773-3850

ON Semiconductor Website: [www.onsemi.com](http://www.onsemi.com)

Order Literature: <http://www.onsemi.com/orderlit>

For additional information, please contact your local Sales Representative